



LASER & OIL MISER VENTED HEATING SYSTEMS ACCESSORIES

USE ONLY TOYOSTOVE & OIL MISER GENUINE PARTS AND ACCESSORIES
ALL PARTS AND ACCESSORIES ARE UL/CSA/ETL LISTED.

ACCESSORY/PART NO.

USE/DESCRIPTION

Standard Flue Pipe
#20479891

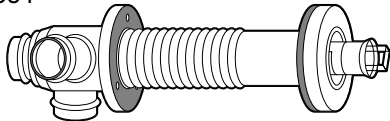

For Laser 30, Laser 56 (H, I, J), Laser 56MH, Laser 73 (K, L, M, N), Laser 73MH, OM-22, Laser 73AT (K, L, M, N), Laser60 AT, OM-23

Standard Flue Pipe
#20478501

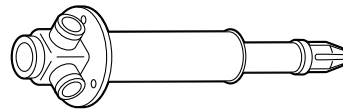

For all Vented Heater models except Laser 30, Laser 56 (H, I, J), Laser 56MH, Laser 73 (K, L, M, N), Laser 73MH, OM-22, Laser 73 AT (K, L, M, N), Laser 60AT, OM-23

Flue Pipe Extension

For use with Standard Flue Pipe #20479891

#20479887

For use in wall thickness from 9 to 13 in.

#20479873

For use in wall thickness from 13 to 16 in.

#20479874

For use in wall thickness from 16 to 20 in.

#20479875

For use in wall thickness from 20 to 24 in.

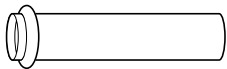

Extension Pipe Kits

For Use With:



Laser Vented Heater through-the-wall installations where the heater is to be located away from the flue pipe.

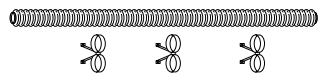

Contains all parts necessary for extension installations as specified in the chart below.

	LONG	MEDIUM	SHORT
PART NUMBER	20479898	20479897	20479896
Length capacity for extension installations	61-3/4 to 78-3/4 inches	22-1/2 to 39-3/8 inches	12-5/8 to 19-5/8 inches

Installation Hardware Kit

#20475580 For all Laser vented heaters except Laser 56 (H, I, J), Laser 73 (K, L, M, N), OM-22 (B, C, D), OM-23, Laser 60AT, Laser 30 (B, C)

Air damper (E) (#20474965) Wall bracket (2 sets) (#20474962)
 Air damper (S) (#20474966) Includes: 6 Wood screws
 Pipe holder (#20474963) 2 Machine screws
 Pipe stopper (#20474964) 2 Wing nuts
 Hose band (#20474977) Intake air cap (#20474949)

#20478786 For Laser 56 (H, I, J), Laser 73 (K, L, M, N)

Oil catch (#20474925) Hose band (#20474977)
 Intake air cap (#20474949) Bent joint (L) (#20474984)
 Intake pipe (#20474951) Spacer (#20478967)
 Wall bracket (#20474962) Exhaust air cap (#20479845)
 Pipe holder (#20474963) Exhaust extension pipe (S) (#20479856)
 Pipe stopper (#20474964) Flue pipe (#20479891)
 L-shaped hose (#20474975)

#20475586 For all Laser vented heaters except Laser 56 (H, I, J), Laser 73 (K, L, M, N), OM-22 (B, C, D), OM-23, Laser 30 (B, C)

Oil catch (#20474925) Flue pipe gasket (#20474974)
 Intake air cap (#20474949) L-shaped hose (#20474975)
 Wall bracket (2 sets) (#20474962) Hose band (#20474977)
 Pipe holder (#20474963) Sleeve cap (#20474978)
 Pipe stopper (#20474964) L-shaped exhaust pipe (#20479861)
 Air damper (E) (#20474965) Wall sleeve with nut (#20479867)
 Air damper (S) (#20474966) Bent joint (#2047884)
 Inner sleeve flange (#20474968) Exhaust extension pipe (S) (#20479856)
 Outer sleeve flange (#20474969) Intake pipe (#20474951)
 Flange gasket (#20474971)

#20479880 For OM-22, OM-23, Laser 30

Oil catch (#20474925) Hose band (#20474977)
 Intake air cap (#20474949) Wall bracket (2 sets) (#20479562)
 Pipe holder (#20474963) Pipe stopper (#20479864)

Does not include the Flue Pipe (#20479891), Inlet Hose (#20474951), L-Shaped Hose (#20474975) (2 pcs.), Insulating Cloth Cover (#20474955) and Bent Joint (#20479884) for OM-22/23 and (#20479584) for Laser 30.

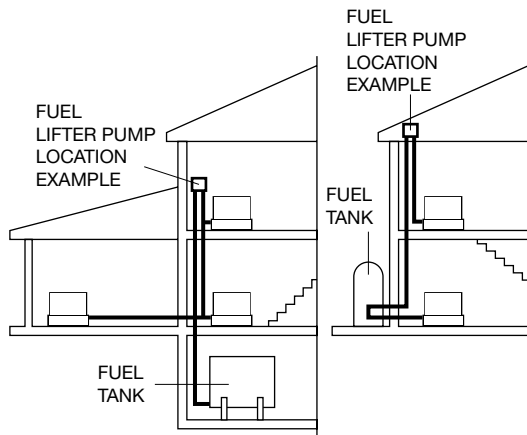

FUEL LIFTER PUMP/GRAVITY
 NOTE: Max. Lifting Height : 26 ft.

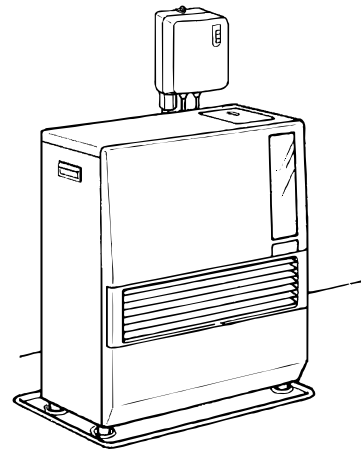

FUEL LIFTER PUMP
 (CAN BE POSITIONED BEHIND UNIT)

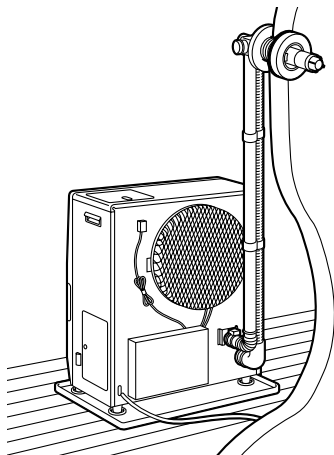

LONG, MEDIUM OR SHORT
EXTENSION KIT

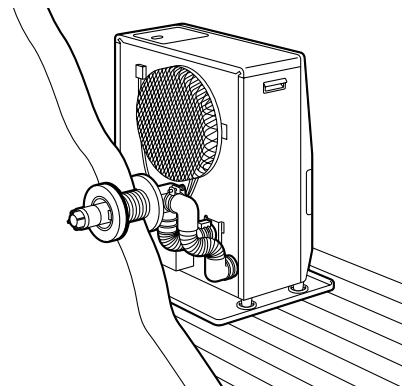

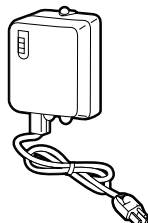
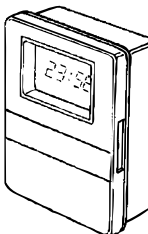

STANDARD OR LONG FLUE PIPE

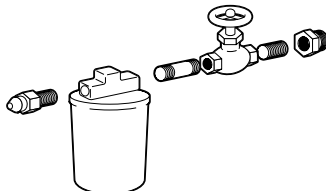
<p>FUEL LIFTER PUMP MODEL OPT-91UL #20477500</p> 	<p>Pumping system for use with one or more Laser and/or Oil Miser Heating Systems where gravity fed does not meet specifications. (see owner's manual.) Automatic recovery feature after power outage.</p>	<p>Weekly Timer #20478302</p> 	<p>Weekly programmable timer with battery back-up memory. Can be used for Models Laser 56, Laser 73, Laser 73AT and Laser 60AT.</p>
---	--	--	---

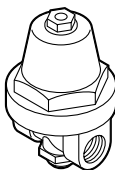
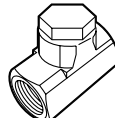
<p>External Fuel Supply Installation Kit #10005098</p> 	<p>For installation of external fuel supply system for all Laser & Oil Miser Vented Heaters. Contains all necessary parts except fuel drum and copper tube. Can also be used in conjunction with the Fuel Lifter Pump. KIT CONTENTS: 2 × 3/8 fusible link valve (#10005597) 3 × 3/8 x 3/8 brass flare hall union adaptors 2 × 3/8 check valve (#10005096) 3 × 3/8 flare nuts 2 × 3/4 x 3/8 galvanized nipple 1 × 3/8 x 3/8 union 2 × 3/8 x 2 galvanized close nipple 1 × oil filter assembly (#10005095) 2 × 3/4 x 3/8 bushing Also, replacement of oil filter cartridge (#10005095) is available.</p>
--	---

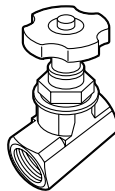
<p>Pressure Reducing Valve #10005099</p> 	<p>If the maximum height from top of the fuel tank to the bottom of the heater exceeds 8-1/2 ft., a fuel pressure reducing valve, preset at 2.5 psi, is required.</p>	<p>Check Valve #10005096</p> 	<p>For all vented heaters</p>
---	---	---	-------------------------------

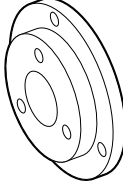
<p>Fusible Link Valve #10005597</p> 	<p>For all vented heaters</p>	<p>Spacer #20478967</p>  <p>(3)</p> 	<p>For use with Standard Flue Pipe #20479891 with Screw M (#20474272) × 3</p>
---	-------------------------------	--	---

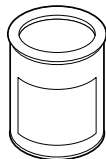
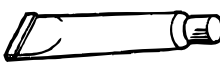
<p>Touch-up-paint #20475961 (Gray) #20475962 (White) #20479561 (Royal White) #20479572 (Black) #20479862 (Silky White)</p> 	<p>Can be used for small scratches or flaws. CONTENTS: 50 cc</p>	<p>Burner Mat Adhesive #20478526</p> 	<p>For all vented heaters except Laser 56 (H, I, J), Laser 60AT, OM-22, OM-23 CONTENTS: 0.04 lbs.</p>
---	---	--	--

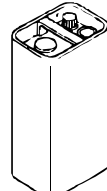
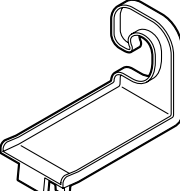

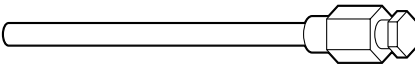







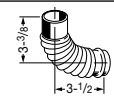

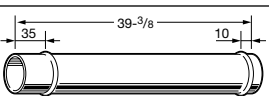

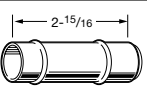
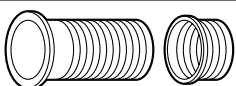
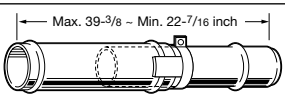

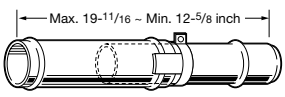

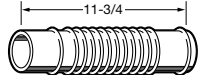

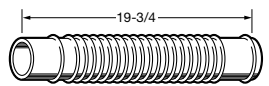

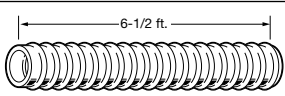
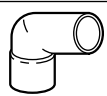
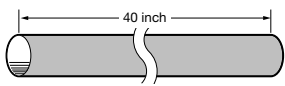
<p>Removable Fuel Tank with Hose for Laser 55/56 #20475922</p> 	<p>Tank capacity: 1.95 gal. NOTE: Fuel supply hose for Laser 55/56: #20475925</p>	<p>Oil Guide #20479725</p> 	<p>For OM-22, OM-23 only</p>
---	--	--	------------------------------

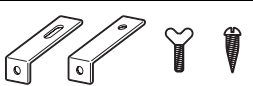
<p>Joint Attaching Screw Kit #20479590</p>	<p>For Laser 30, OM-22, OM-23 KIT CONTENTS 1 × Screw 1U (#20478091) 1 × Metal washer 1 × Fiber gasket</p>	<p>Overflow Tube #20474901</p> 	<p>For OPT-81UL, OPT-91UL Only needed when 2 or more lifter pumps are used in series. (See owner's manual for details.)</p>
---	--	--	---

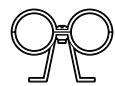
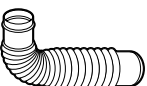
<p>Gasket Service Kit #20479830 KIT CONTENTS: 1 × Igniter gasket (#17187582) 1 × Flame rod gasket (#20479511)</p>	<p>For OM-22, OM-23 only 1 × Relief gasket (#20479591) 1 × Fuel nozzle gasket (#20479883)</p>	<p>1 × Outside nozzle gasket (#20479885) 1 × Heat exchanger gasket (#20479893)</p>
---	---	--

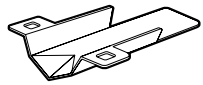
For specialized installations, the additional extension kit parts shown below may be purchased from a TOYOSTOVE dealer. In any installation the following limitations must NOT be exceeded:

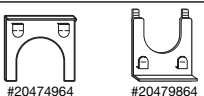
1. The total length of extension pipe between the heater and the outside tip of the flue pipe must not exceed 10 feet each for the air intake pipe and the exhaust pipe.
2. Neither air intake pipe nor the exhaust pipe may have more than 3 elbows, counting the elbows at the heater. The air intake elbow supplied with the heater and the integral bends in the flue pipe are not counted as elbows.

PART NAME/PART NUMBER	DESCRIPTION	PART NAME/PART NUMBER	DESCRIPTION
L-Shaped Exhaust Joint #20479861 (Connection between exhaust pipes)		Air Damper (E) #20474965 Air Damper (S) #20474966 (For Laser 52/55 only)	
Exhaust Extension Pipe #20479872		Air Damper #20478366 (for Laser 56 / 73 / 60AT) #20479567 (for Laser 30) #20479866 (for OM-22)	
Exhaust Extension Pipe (S) #20479856 (Laser 52/55/56 only)		Wall Sleeve with Sleeve Nut #20479867 (For 20478501) #20479870 (For 20479857)	
Adjustable Exhaust Pipe (L) #20479853		Inner Sleeve Flange #20474968 For flue pipe (#20478501)	
Adjustable Exhaust Pipe (S) #20479858		Outer Sleeve Flange #20474969 For flue pipe (#20478501)	
Flexible Exhaust pipe (M) #20479888		Flange Gasket #20474971 For wall sleeve For flue pipe (#20478501)	
Flexible Exhaust pipe (L) #20479889		Flue pipe Gasket #20474974 For flue pipe (#20478501)	
Intake Pipe #20474951		L-Shaped Hose #20474975	
Insulating Cloth Cover #20474955		Hose Band #20474977	
Wall Bracket (2 sets) #20474962 #20479562 (for Laser 30 / OM-22)		Intake Pipe Joint #20474954	
Pipe Holder #20474963		Pipe Support Hardware #20474950	
Bent Joint #20474984 #20479584 (for Laser 30) #20479884 (for OM-22)		Sleeve Cap #20474978 Use with wall sleeve only (#20479867)	
O-ring (ø39) (Exhaust of Flue Pipe) #20475879		Oil Catch #20474925	
O-ring (ø42) (Intake of Flue Pipe) #20475880		Exhaust Air Cap (Metal) #20479845	
Pipe Stopper #20474964 #20479864 (for OM-22, OM-23 only)		Intake Air Cap (Rubber) #20474949	

*Check state and local codes for permitted uses.

*Subject to change with or without notice.

TOYOTOMI U.S.A., INC.

604, Federal Road, Brookfield, CT 06804
(203)775-1909

DISTRIBUTOR / DEALER NAME